	MARIANO MARCOS STATE UNIVERSITY		Document Code	PD-FRM-002
	Procurement Division		Revision No.	5
Request for Quotation (RFQ) (Goods and Services)		Effectivity Date		Page 1 of 2 April 20, 2022

REQUEST FOR QUOTATION (RFQ)

Date: 5/26/2022
 PR No. 2022-05-184(9/10/01)

Sir/Madam:

Please quote your lowest price on the item/s listed below, and submit your quotation duly signed by you or your duly authorized representative not later than **3 days** subject to the Terms and Conditions provided at the last page of this RFQ.

Delivery period must be at least within 30 days upon receipt of the Notice to Proceed or Purchase Order.

For any clarification, you may email us at bac@mmsu.edu.ph.

NATHANIEL R. ALIBUYOG
BAC Chair

ITEM	QTY	Unit	ITEM DESCRIPTION	ABC/unit	UNIT PRICE
	1	lot	47 10 lbs Dry Chemical Fire Extinguisher, Class ABC (RED)	149,615.50	
			2 10 lbs HCFC - 123 Chemical Fire Extinguisher, Class ABC (GREEN) (Stored Pressure Type)		
			includes delivery and installation (please see attached plan/ drawing)		

TOTAL ESTIMATED BUDGET: 149,615.50

REMARKS/NOTE: _____

Disclaimer: Reproduction of this form is allowed subject to compliance to the Documented Information Procedure established by MMSU.

	MARIANO MARCOS STATE UNIVERSITY Procurement Division		Document Code	PD-FRM-002
	Request for Quotation (RFQ) (Goods and Services)		Revision No.	5
			Effectivity Date	April 20, 2022
Page 2 of 2				

After having carefully read and accepted your Terms and Conditions, I/we submit our quotation/s on the item/s at prices indicated above.

Business Name: _____
 Business Address: _____
 Printed Name of the Owner: _____
 Signature over Printed Name
 Tel. No./Cellphone No./e-mail address

 Date

 PhilGEPS Registration Number: _____
 Business Permit: _____
 Omnibus Sworn Statement: _____
 Annual Income Tax Return: _____

Canvassed by: _____

TERMS AND CONDITIONS:

1. Bidders shall provide correct and accurate information required in this form.
2. Bidders may quote for any or all of the items.
3. Bidders shall submit a copy of the following documents along with the Quotation:
 - a. PhilGEPS Registration Number
 - b. Mayor's Permit / Business Permit
 - c. Omnibus Sworn Statement (for ABC's above P 500,000.00)
 - d. Income/Business Tax Return (for ABC's above P 500,000.00)
 - e. Certificate of Public Conveyance (CPC) for vehicle rentals and truckings
4. Price quotation/s, to be denominated in Philippine peso, shall include all taxes, duties and/or levies payable.
5. Quotations exceeding the Approved Budget for the Contract shall be rejected.
6. Award of contract shall be made to the lowest quotation which complies with the minimum technical specifications and other terms and conditions stated herein.
7. Any interlineations, erasures or overwriting shall be valid only if they are signed or initialed by you or any of your duly authorized representative/s.
8. The item/s shall be delivered according to the requirements specified in the Technical Specifications.
9. The University has the right to inspect and/or test the goods to confirm their conformity to the technical specifications.
10. Liquidated damages equivalent to one tenth of one percent (0.1%) of the value of the goods not delivered within the prescribed delivery period shall be imposed per day of delay.

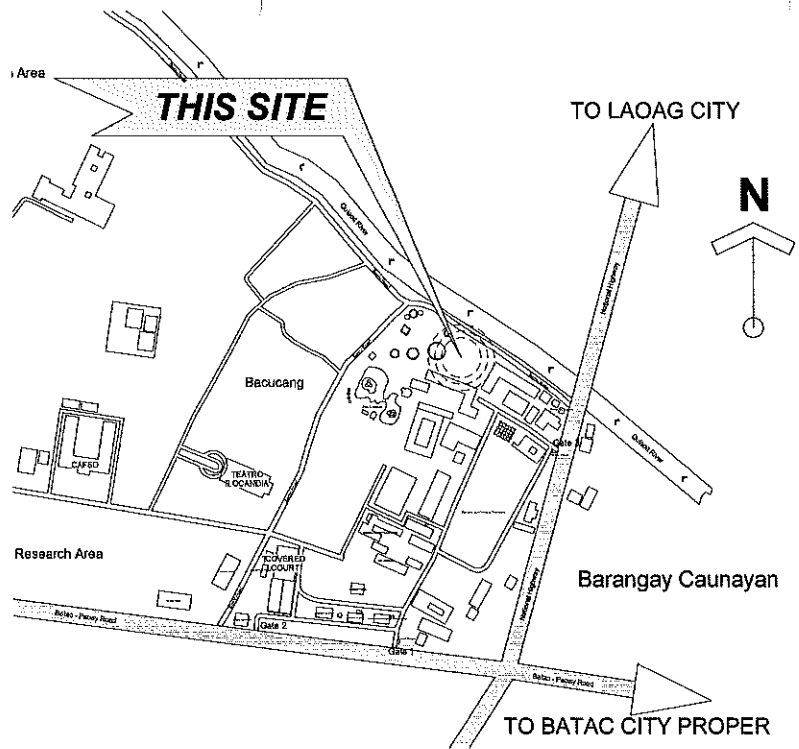

1 LOCATION MAP

MAXIMUM AREA PER EXTINGUISHER
 CLASSIFICATION OF HAZARD = MODERATE HAZARD
 MODERATE HAZARD = 100 m²
 LOW HAZARD = 200 m²
 HIGH HAZARD = 75 m²

FIRE EXTINGUISHER			
Description	Size	Quantity	Location
FIRE EXTINGUISHER, CLASS ABC WITH HANGER BRACKET	10 lbs	47	As shown (See installation Detail)
HCFC-123 CHEMICAL (DICHLORO TRIFLUORETHANE) CLASS ABC WITH HANGER BRACKET	10 lbs	2	As shown (See installation Detail)

2 SCHEDULE OF EQUIPMENT

NOTES

1. THE SELECTION AND PLACEMENT OF PORTABLE FIRE EXTINGUISHER SHALL BE IN ACCORDANCE WITH RA9514 THE FIRE CODE OF THE PHILIPPINES.
2. FIRE EXTINGUISHERS SHALL BE LOCATED WHERE THEY WILL BE READILY AVAILABLE AND ACCESSIBLE IN THE EVENT OF FIRE.
3. FIRE EXTINGUISHER SHALL NOT BE OBSTRUCTED FROM VIEW.
4. THE TOP OF PORTABLE FIRE EXTINGUISHER SHALL BE INSTALLED NOT MORE THAN 1500mm ABOVE THE FLOOR.
5. FIRE EXTINGUISHER SHALL BE PLACED SO THAT OPERATING MANUAL SHALL FACE OUTWARD. THE LOCATION OF FIRE EXTINGUISHER SHALL BE MARKED CONSPICUOUSLY.
6. THE MINIMUM TRAVEL TO EXTINGUISHER SHALL NOT BE MORE THAN 15 METERS ALONG PATHWAY.

3 GENERAL NOTES

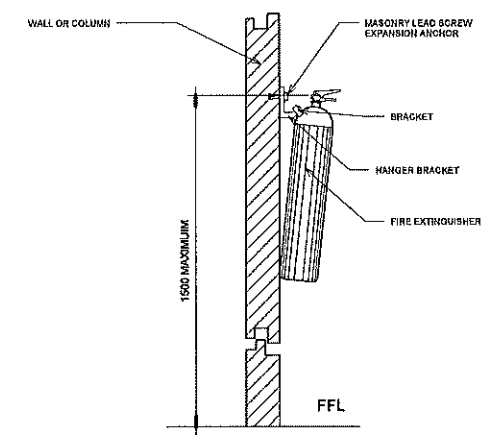

4 PORTABLE FIRE EXTINGUISHER DETAIL

	FROM THE OFFICE: PHYSICAL PLANNING AND DEVELOPMENT OFFICE 2/F 202 ADMINISTRATION BLDG. MARIANO MARCOS STATE UNIVERSITY CITY OF BATANG, 2008 ILOCOS NORTE TELEFAX: +63 (77)92-3191	DRAWN BY: DENNIS G. ACANTILAN PREPARED BY: DENNIS G. ACANTILAN MECHANICAL ENGINEER	SIGNED & SEALED BY: [Signature] PROFESSIONAL MECHANICAL ENGINEER	PROJECT TITLE: REPLACEMENT OF FIRE EXTINGUISHER AT COLLEGE OF MEDICINE	CONFORME: POLIO MENDOZA, JR. RECOMMENDING APPROVAL: TOMASO R. [Signature]	APPROVED BY: [Signature] SHIRLEY G. AGRON UNIVERSITY PRESIDENT	SHEET CONTENTS: -AS SHOWN-	REVISION AND DATE:	SHEET NO:
	LOCATION: MMSU COM-CITY OF DATAO, ILOCOS NORTE		DATE ISSUED: DATE: 12-15-17/20 TIME:		PRO NO. / VALIDITY: PRO NO. / VALIDITY:		SHEET NO. / TOTAL SHEETS:		REVISION AND DATE:

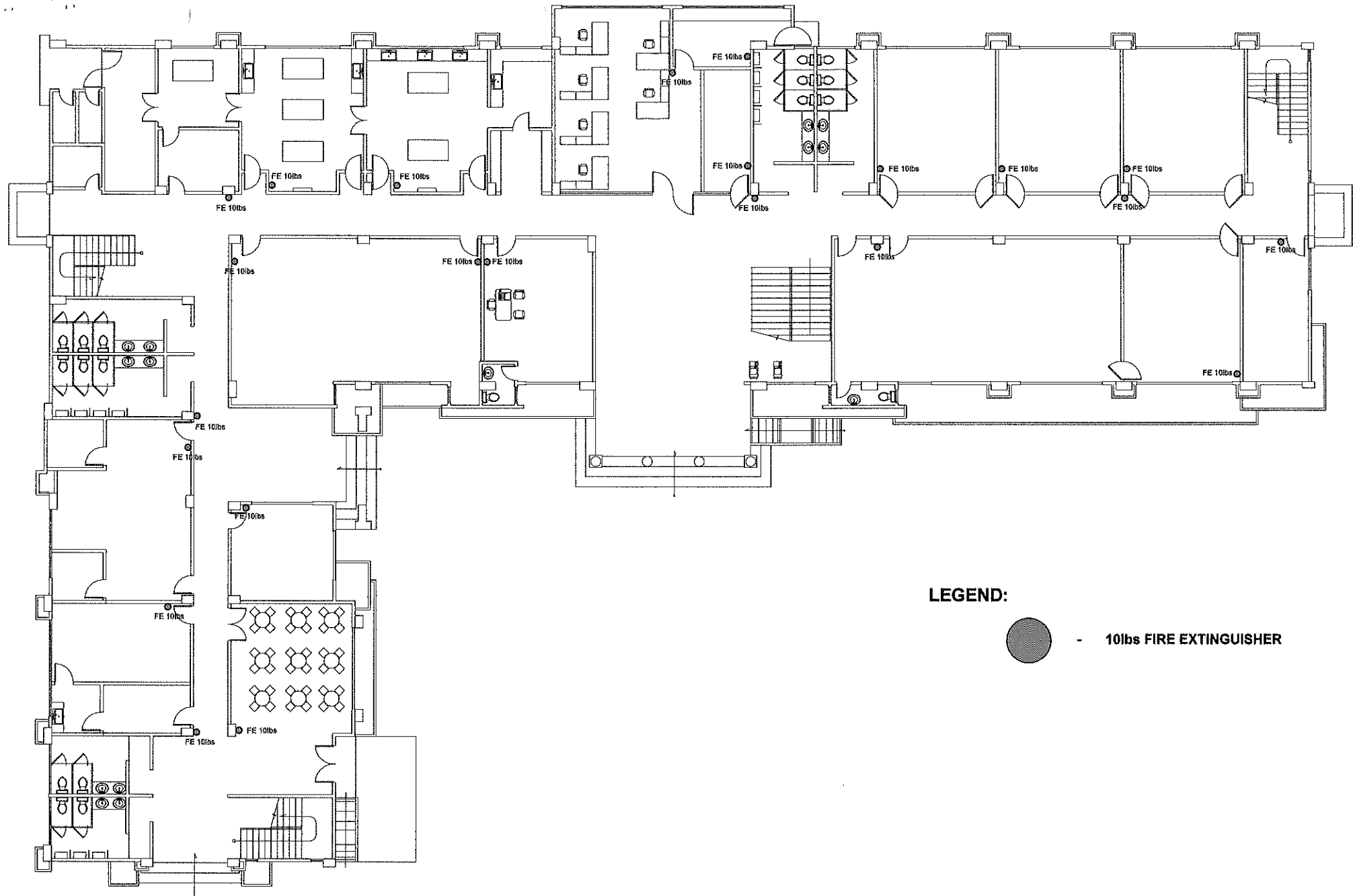









LEGEND:

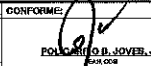

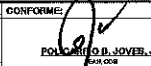

- 10lbs FIRE EXTINGUISHER

1 **GROUND FLOOR FIRE EXTINGUISHER PLAN**
1 : 110 meters

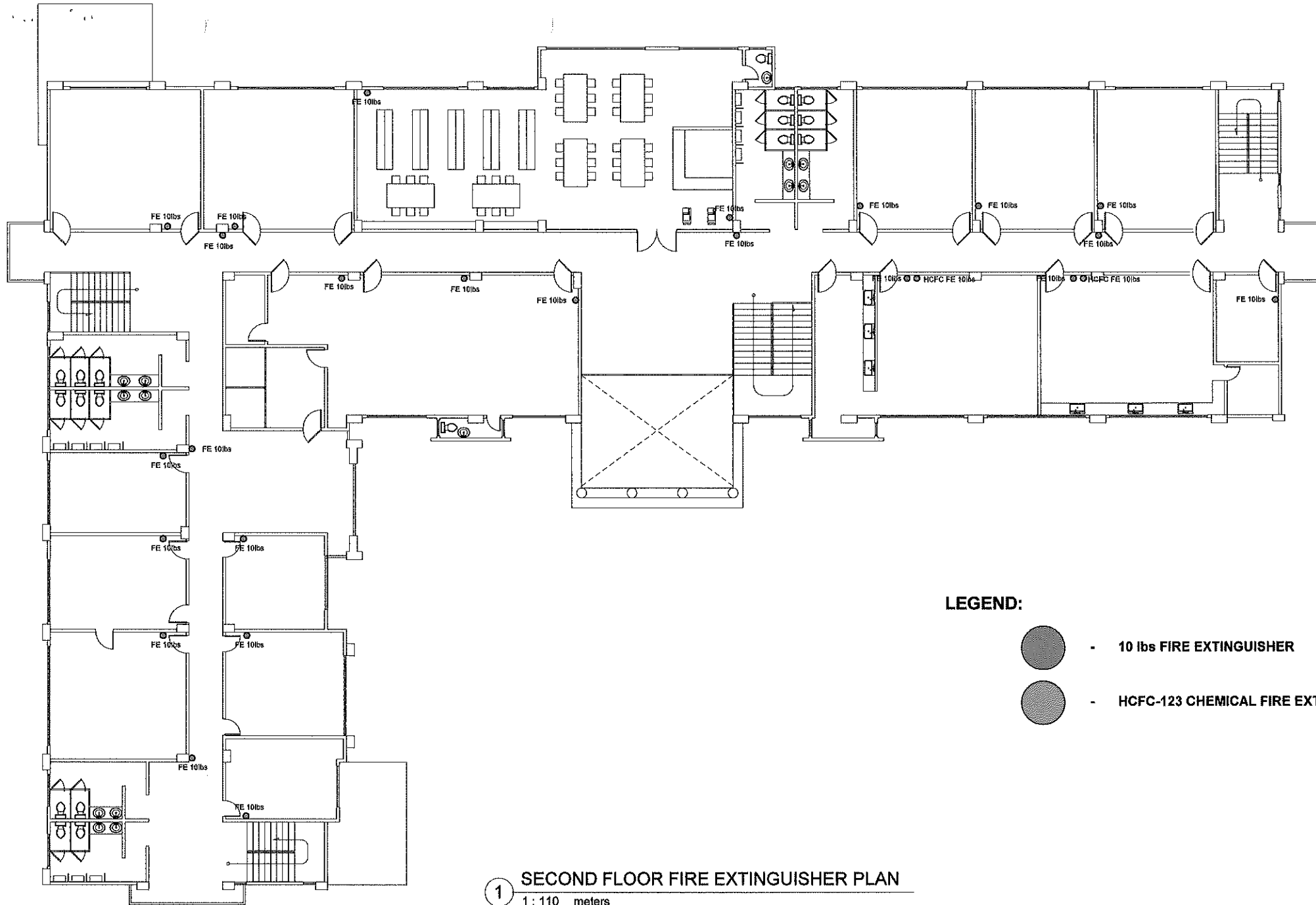
	FROM THE OFFICE: PHYSICAL PLANNING AND DEVELOPMENT OFFICE 2/F 232 ADMINISTRATION BLDG. MARIANO MARCOS STATE UNIVERSITY CITY OF BATAO, 2409 ILOCOS NORTE TELEFAX: +63 (77)92-3191	DRAWN BY:  DENNIS CLYDE O. AGANILAO MECHANICAL ENGINEER	SIGNED & SEALED BY:  DENNIS CLYDE O. AGANILAO MECHANICAL ENGINEER	PROJECT TITLE: REPLACEMENT OF FIRE EXTINGUISHER AT COLLEGE OF MEDICINE	CONFORME:  ROMEO B. DUGAN REGISTERED PROFESSIONAL ENGINEER	APPROVED BY:  SHIRLEY D. AGRIPIA UNIVERSITY PROFESSOR	SHEET CONTENTS: -AS SHOWN- <small>Drawings and specifications and other written documents shall remain the property of the State University of Bataan. No part of this drawing shall be reproduced or transmitted in any form or by any means, electronic, mechanical, photocopying, recording, or by any information storage and retrieval system, without the prior written permission of the State University of Bataan.</small>	REVISION AND DATE: <table border="1"> <tr><td> </td><td> </td></tr> <tr><td> </td><td> </td></tr> <tr><td> </td><td> </td></tr> </table>							SHEET NO.: 
FROM THE OFFICE: PHYSICAL PLANNING AND DEVELOPMENT OFFICE 2/F 232 ADMINISTRATION BLDG. MARIANO MARCOS STATE UNIVERSITY CITY OF BATAO, 2409 ILOCOS NORTE TELEFAX: +63 (77)92-3191	DRAWN BY:  DENNIS CLYDE O. AGANILAO MECHANICAL ENGINEER	SIGNED & SEALED BY:  DENNIS CLYDE O. AGANILAO MECHANICAL ENGINEER	PROJECT TITLE: REPLACEMENT OF FIRE EXTINGUISHER AT COLLEGE OF MEDICINE	CONFORME:  ROMEO B. DUGAN REGISTERED PROFESSIONAL ENGINEER	APPROVED BY:  SHIRLEY D. AGRIPIA UNIVERSITY PROFESSOR	SHEET CONTENTS: -AS SHOWN- <small>Drawings and specifications and other written documents shall remain the property of the State University of Bataan. No part of this drawing shall be reproduced or transmitted in any form or by any means, electronic, mechanical, photocopying, recording, or by any information storage and retrieval system, without the prior written permission of the State University of Bataan.</small>	REVISION AND DATE: <table border="1"> <tr><td> </td><td> </td></tr> <tr><td> </td><td> </td></tr> <tr><td> </td><td> </td></tr> </table>							SHEET NO.: 	



- LEGEND:**
-  - 10 lbs FIRE EXTINGUISHER
 -  - HCFC-123 CHEMICAL FIRE EXTINGUISHER

1 SECOND FLOOR FIRE EXTINGUISHER PLAN
1 : 110 meters

 <p>PHYSICAL PLANNING AND DEVELOPMENT OFFICE 31F 202 ADMINISTRATION BLDG. MARIANO MARCOS STATE UNIVERSITY CITY OF BATAV, 3109 ILOCOS NORTE TELEFAX: +62 (77) 92 5191</p>	<p>FROM THE OFFICE:</p>	<p>DRAWN BY: <i>[Signature]</i> 5/14/22 DENNIS SLYDE G. AGARTILADO MECHANICAL ENGINEER</p>	<p>SIGNED & SEALED BY: <i>[Signature]</i> PROFESSIONAL MECHANICAL ENGINEER</p>	<p>PROJECT TITLE: REPLACEMENT OF FIRE EXTINGUISHER AT COLLEGE OF MEDICINE</p>	<p>CONFORME: <i>[Signature]</i> ROSELIO D. JAVIER, JR. CEAL, COE</p>	<p>APPROVED BY: <i>[Signature]</i> BIBILEY D. AGRUPAN MECHANICAL ENGINEER</p>	<p>SHEET CONTENTS: -AS SHOWN-</p>	<p>REVISION AND DATE:</p>	<p>SHEET NO.: M-3</p>
	<p>PREPARED BY: <i>[Signature]</i> 5/17/22 DENNIS SLYDE G. AGARTILADO MECHANICAL ENGINEER</p>	<p>PROJ. NO. / VALIDITY: PTR: PLACE ISSUED: DATE: TIN:</p>	<p>LOCATION: MMBU COM-CITY OF BATAV, ILOCOS NORTE</p>	<p>RECOMMENDATION APPROVAL: <i>[Signature]</i> ROSELIO D. JAVIER, JR. CEAL, COE</p>	<p><small>Drawings and specifications and other parts of documents shall remain the property of the office. No part of the drawings or specifications shall be reproduced or transmitted in any form or by any means, electronic, mechanical, photocopying, recording, or by any information storage and retrieval system, without the prior written permission of the office.</small></p>				